

CANTILEVER ARMS

Specification: BS 6946:1988

Finishing: hot dip galvanized to ISO 1461:1999

Item No.	A mm	Recommended UDL Kgf for vertical channel DR41	Wt. each kg
CA01150	160	680	0.80
CA01300	310	356	1.17
CA01450	460	240	1.59
CA01600	610	181	2.03
CA01750	760	143	2.53

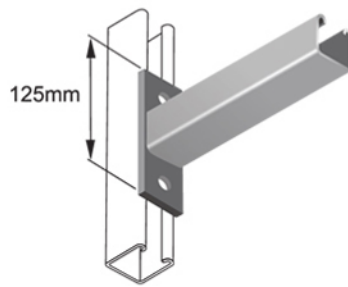

Item No.	A mm	Recommended UDL Kgf for vertical channel DR41	Wt. each kg
CA02150	160	680	0.80
CA02300	310	356	1.17
CA02450	460	240	1.59
CA02600	610	181	2.03
CA02750	760	143	2.53

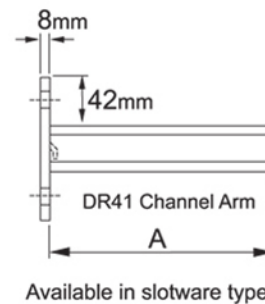
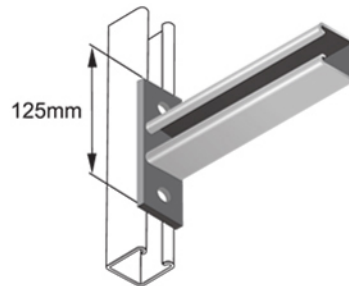

Item No.	A mm	Recommended UDL Kgf for vertical channel DR41D	Wt. each kg
CA03300	310	609	2.13
CA03450	460	410	3.01
CA03600	610	309	3.72
CA03750	760	248	4.66

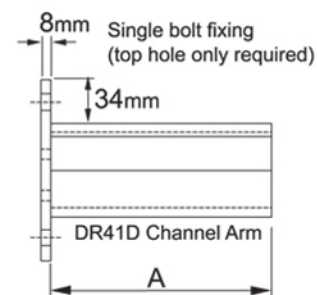
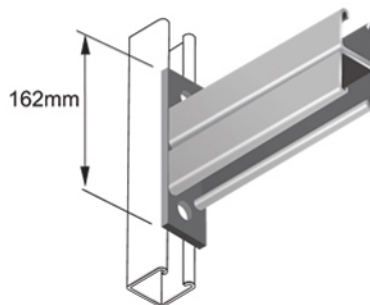

Item No.	A mm	B mm	C mm	Recommended UDL Kgf for vertical channel DR41	Wt. each kg
CA04750	760	270	608	460	4.63
CA04900	910	330	728	460	4.78
CA041050	1060	380	848	460	5.67

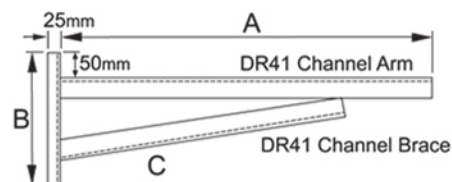
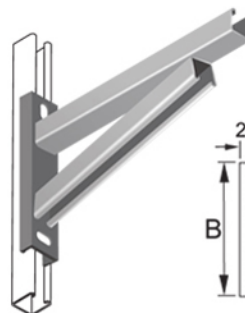

Grade 304 & 316 Stainless Steel and special length available on request
 Ordering example : Hot dip galvanized CA01/150 Channel Arms (item no : 4001101150)